

453

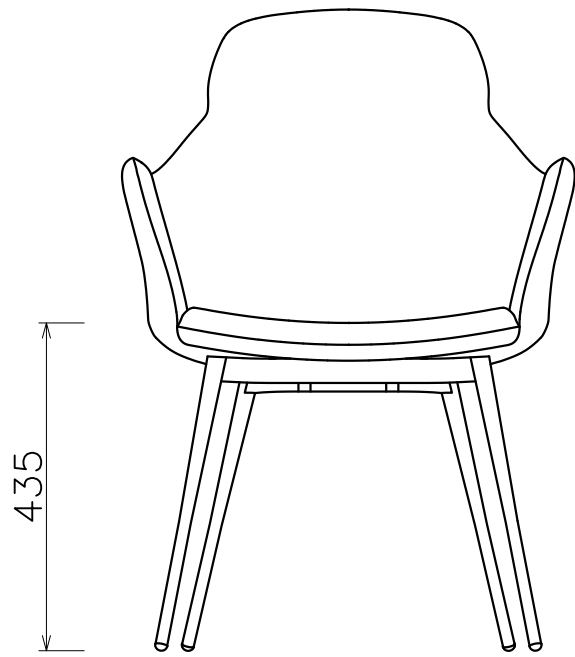

435

599

433

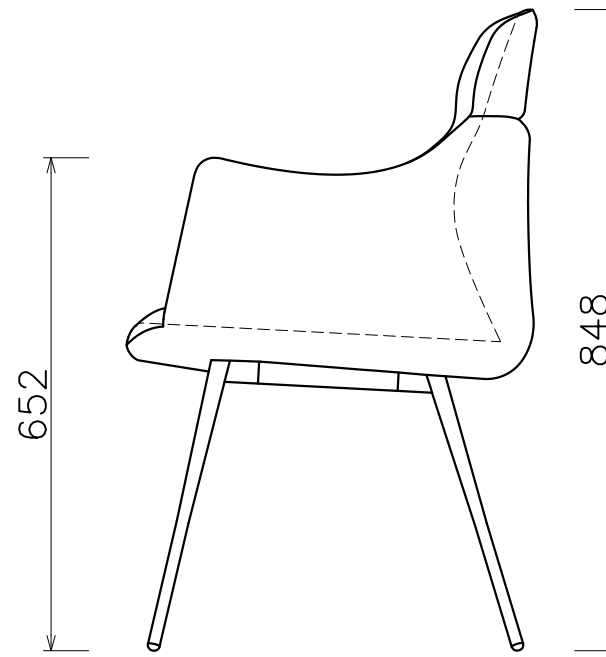

652

543

848