

446

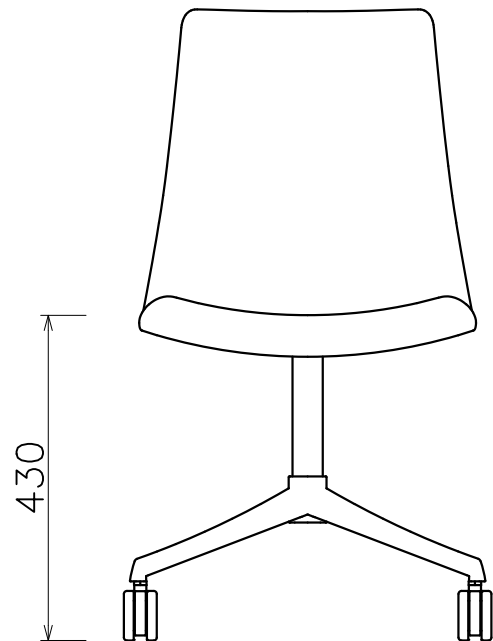

430

486

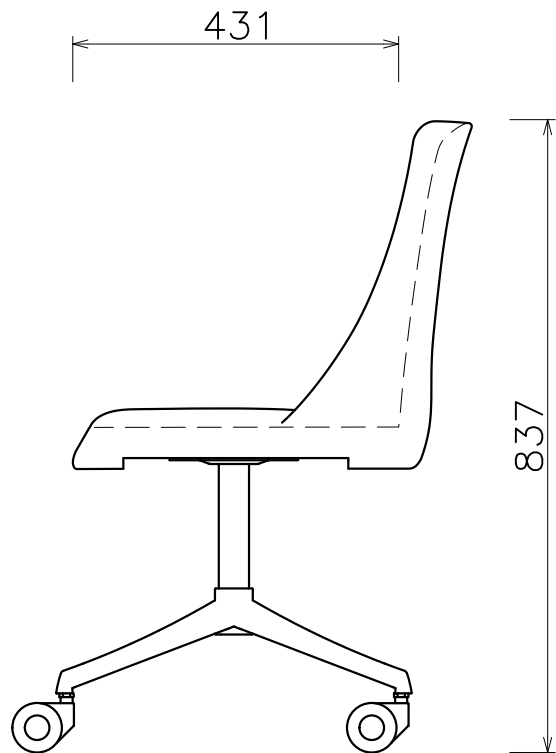

431

837

608